

HAUGHTON

QUICK LOCATOR GUIDE

Belts	650
Brushes	652
Capacitor	664
Car Signal Components	650
Button Components	650
Key Switches and Keys	650
Coils	651-652
Gongs	650
Door Parts and Equipment	653-656
Contacts	656
Door Clutch Roller Assemblies	655
Key, Lunar	653
Photo Cell Components	653
Resistors	655
Safe Ray System Components	653
Safety Edge Assembly	655-656
Sheaves	654
Machine Parts	657
Seals, Gaskets, Bearings	657
Tachometers	657
Motors	654, 657
Printed Circuit Boards	664
Rectifiers	658
Relay Parts	658-663
Contacts	658-662
Magnetic Leveling Switches	658
Optical Leveling Switches	658
Plug-in Relays	659
Telephone Type Relays	663
Resistors	655, 664
Stepper Switches	664
Timers	664
Transformers	664
Wheels and Rollers	665-667
Door Clutch Roller Assembly	655, 665
Hanger Rollers	665-666
Interlock Roller	656, 665
Limit Switch Roller	658, 667
Roller Guide Assemblies	666-667
Roller Guide Wheels	666-667
Tach Roller	667

Car Signal Components



HB-1



HB-1B



HB-1C

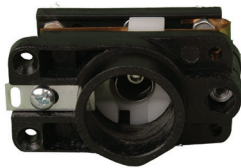

HB-1D



HB-3

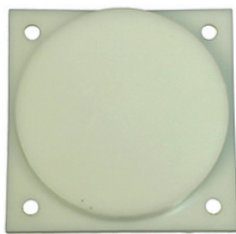

HB-4



HK-1



HK-2



HK-3



HK-4



HBLT-1



HBLT-2



HB-2

S.E.E.S. #	O.E.M. #	Description
HB-1-	3-40080-	Button for type "H" pushbutton assembly. White button with black marking, face 1-3/32" diameter x 1-3/32" long. Specify marking, i.e. HB-1-3
HB-1-BLANK-ADA		Button , Type H, Blank ADA
HB-1B	3-40218-14	Collar , black for type "H" buttons
HB-1C	3-40150-54	Switch Element , 2 N.O., "H" button
HB-1D	3-40229-36	Button , switch element assembly "H" series 1 N.O. & 1 N.C.
HB-3	3-400063-32	Halo , red "RUN-STOP" for toggle switch
HB-4	3-40218-98	Lens , Hall lantern lens, 3" diameter, white
HKB-1	3-40078-11	Key Switch Bezel , Red
HKB-2	3-40078-18	Key Switch Bezel , Black
HK-1	3-40079-51	Key , 332CLC key code
HK-2	3-40216-69	Key , Haughton XX3117 key
HK-3		Fire Service Key , barrel ACE type
HK-4	#2007	Key , Haughton car cop key #2007
HK-5	AE102	Key , Emergency Car Call AE102
HK-5	AE102	Key , Emergency Car Call AE102
HK-6		Key , Haughton Esc #T112, Up-Down Direction Run
HK-7		Key , AE101
HK-8		Key , AE103
HK-9		Key , AE104
HK-10		Key , AE105

Belts

S.E.E.S. #	O.E.M. #	Description
HBLT-1	3-40133-54	Belt for door operator, Poly-V-Belt type 6J, 55"
HBLT-2	3-40139-87	Belt for limit switch, Poly-V-Belt type 4J, 43"

Gongs

S.E.E.S. #	O.E.M. #	Description
HB-2	3-40026-99	Gong Assembly , 12 VDC

Coils



HC-1 thru HC-17

I.O. 5/8" x 13/16"
O.D. 1-59/64" x 2-1/8"
Length 1-9/32"

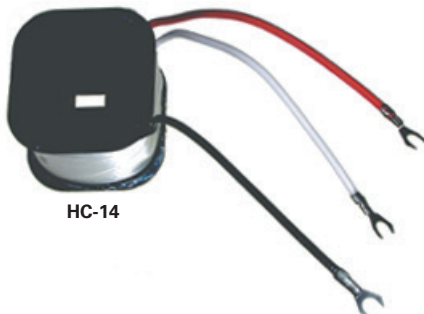

HC-14



HC-18, HC-19, HC-20



HC-21, HC-22

S.E.E.S. #	O.E.M. #	Resistance	Voltage
HC-1	E-2D*	3-23015-09	5,000 230 VDC
HC-2	E-11*	3-23015-23	818 115 VDC
HC-3	E-12	3-23015-10	60 120
HC-4	E-12G**	3-23015-21	60 110
HC-5	E-16	3-23015-04	31 110/55
HC-6	E-20	3-23015-24	187 220/250
HC-7	E-20G**	3-23015-20	187 208
HC-8	E-23*	3-23015-22	3,240 230 VDC
HC-9	E-24	3-23015-16	230 220/240
HC-10	E-24G**	3-23015-19	230 220/240
HC-11	E-26	3-23015-05	145 208/220
HC-12	E-26C*	3-23015-05	95 208/240
HC-13	E-26G**	3-23015-01	145 208/220
HC-15	E-45*	3-23015-17	1,350 115/440
HC-16	E-46	3-23015-06	600 115/440
HC-17	E-48	3-23015-18	920 220/440

*O.D. is 2-11/64" x 2-3/8"

**High temperature applications



HC-23, HC-24, HC-27



HC-25, HC-29



HC-26, HC-28

S.E.E.S. #	O.E.M. #	Resistance	Voltage	Dimensions
HC-14	E-26T, 3-23015-02	Inner winding: 300 Outer winding: 3,400	208/220	5/8" x 13/16" I.D. x 2-11/64" x 2-3/8" O.D. x 1-9/32" L

S.E.E.S. #	O.E.M. #	Resistance	Voltage	Dimensions
HC-18	F-1, 23036	370		1-11/32" I.D. x 3-1/8" O.D. x 2-13/16" L
HC-19	F-2, 23036A	4,500		1-11/32" I.D. x 3-1/8" O.D. x 2-13/16" L
HC-20	F-12, 3-41032-002	450		1-11/32" I.D. x 3-1/8" O.D. x 2-13/16" L
HC-21	K-1, 3-36271-01	795		2-7/64" I.D. x 2-13/16" O.D. x 2-13/16" L
HC-22	K-2, 3-36271-00	2,900		2-7/64" I.D. x 2-13/16" O.D. x 2-13/16" L
HC-23	T-1, 3-36102-13	700	115 VDC	1" I.D. x 2" O.D. x 2-5/8" L
HC-24	T-2, 3-36102-15	2,940	230 VDC	1" I.D. x 2" O.D. x 2-5/8" L
HC-27	T-18, 3-36102-06	1,900	230 VDC	1" I.D. x 2-5/8" O.D. x 2-1/4" L
HC-25	T-8, 3-36102-07	740	80	1" I.D. x 2-1/4" O.D. x 2-3/8" L
HC-29	T-90, 3-36102-02	Field current sensitive 1.7 - 4.0 Amp		1" I.D. x 2-5/8" O.D. x 2-3/8" L
HC-26	T-15, 36102	780	115 VDC	1-1/2" I.D. x 2-1/4" O.D. x 2-5/8" L
HC-28	T-25, 3-36102-01	2,900	230 VDC	1-1/2" I.D. x 2-1/4" O.D. x 2-5/8" L

Coils

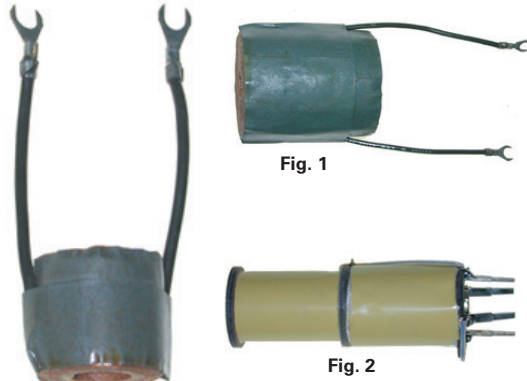

HC-30, HC-31



HC-47

HC-48



HC-52



HC-49, HC-50



HC-51

S.E.E.S. #	O.E.M. #	Resistance	Dimensions
HC-30	23023A	70	33/64" I.D. x 1" O.D. x 15/16" L
HC-31	23023C	265	33/64" I.D. x 1" O.D. x 15/16" L

S.E.E.S. #	O.E.M. #	Fig.	S.E.E.S. #	O.E.M. #	Fig.
HC-32	34-1032-001	1	HC-33	34-1032-006	2
HC-34	34-1032-003	1	HC-34A	34-1032-004	2
HC-34B	34-1032-005	1	HC-38	3-40155-15	2
HC-35	3-40258-34-1	1	HC-39	3-40255-08	2
HC-40	34-1032-007	1	HC-41	34-1032-009	2
HC-42	34-1032-010	1	HC-43	34-1032-011	2
HC-44	34-1032-012	1	HC-46	34-1032-002	2

S.E.E.S. #	O.E.M. #	Description
HC-47	3-40031-88	Brake coil for OH Machine, Motor is flange style, no feet, bolts via ring. I.D. 2-3/8" x 2-3/8", 167 OHMS
HC-48	3-23044-01	Brake coil for EK Machine, Motor with feet and is mounted to machine frame. I.D. 3-1/8" Sq. x 3" H, 110 OHMS, 120 VDC, I.D. 3/4"
HC-49	3-40008-47	Coil , 12V, EN (green) bobbin type coil for type BN and DN relays. <i>See page 662.</i>
HC-50	3-40008-48	Coil , 24V, DN (red) bobbin type coil for type BN and DN relays. <i>See page 662.</i>
HC-51	23031	Coil , B1 for B7 retiring cam, I.D. 1-17/32" min to 1-5/8" max., 330 Ohms
HC-52		Replacement , 110V coil for FRP-75
HC-53	26187	Brake Coil
HC-54	23039	Brake Coil

Brushes

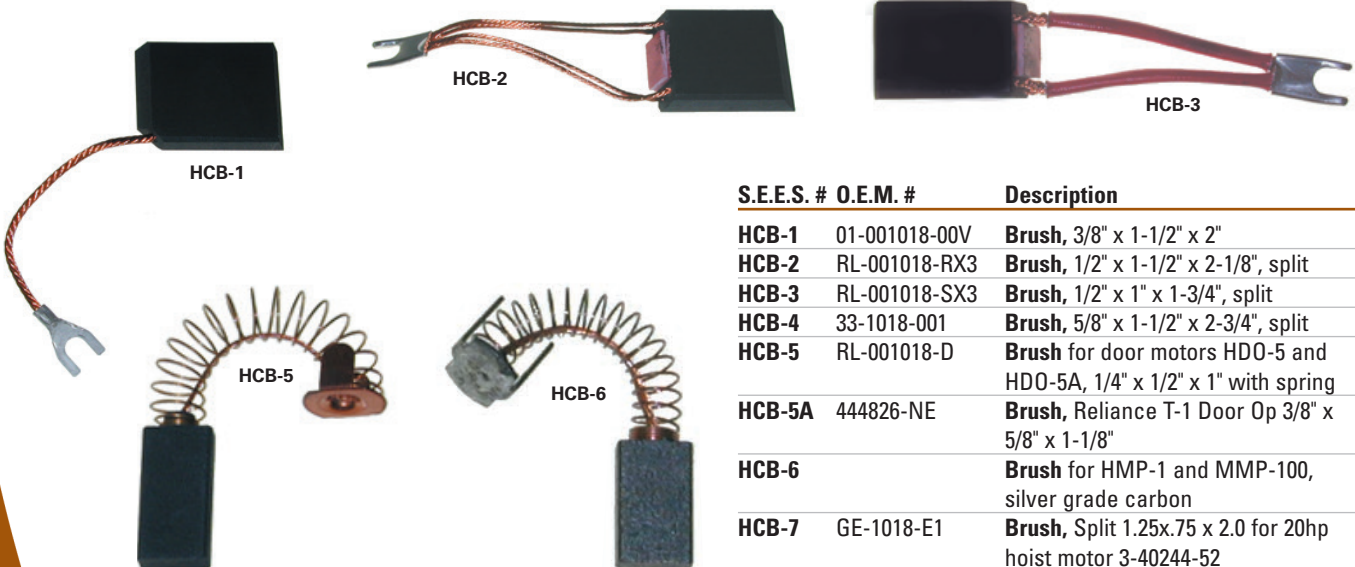

S.E.E.S. #	O.E.M. #	Description
HCB-1	01-001018-00V	Brush , 3/8" x 1-1/2" x 2"
HCB-2	RL-001018-RX3	Brush , 1/2" x 1-1/2" x 2-1/8", split
HCB-3	RL-001018-SX3	Brush , 1/2" x 1" x 1-3/4", split
HCB-4	33-1018-001	Brush , 5/8" x 1-1/2" x 2-3/4", split
HCB-5	RL-001018-D	Brush for door motors HDO-5 and HDO-5A, 1/4" x 1/2" x 1" with spring
HCB-5A	444826-NE	Brush , Reliance T-1 Door Op 3/8" x 5/8" x 1-1/8"
HCB-6		Brush for HMP-1 and MMP-100, silver grade carbon
HCB-7	GE-1018-E1	Brush , Split 1.25x.75 x 2.0 for 20hp hoist motor 3-40244-52

Door Parts and Equipment



HDO-1



HDO-2A



HDO-2

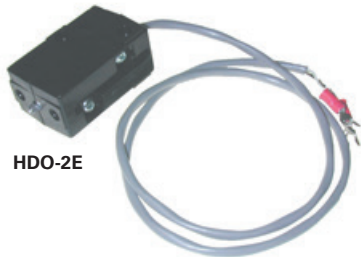

HDO-2E



HDO-2B



HDO-2G



HDO-2C

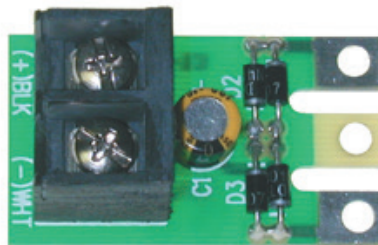

HDO-2F

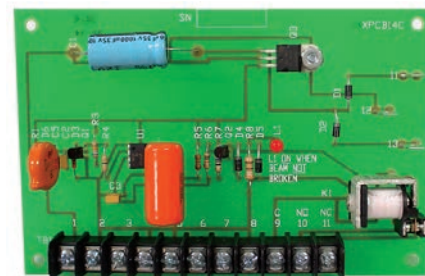

HDO-2D

S.E.E.S. #	O.E.M. #	Description
HDO-1	34-2551-28	Lunar key, fits escutcheon 3-40197-17
HDO-2B	3-40007-66	Photo cell assembly with 20 ft. cable
HDO-2C	3-40007-63	Coiled cord assembly for Safe Ray Light
HDO-2	3-401040-47	Light source and cable assembly
HDO-2G		Emitter Replacement Kit for HE Safe Ray Systems, solid state technology, replaces (2) incandescent light sources
HDO-2E		Emitter source assembly, included in HDO-2G kit
HDO-2F		Power supply printed circuit board, included in HDO-2G kit
HDO-2D	3-40007-82	Amplifier PC Board, for type "HE" safe ray

Door Parts and Equipment



HDO-5



HDO-6



HDO-7

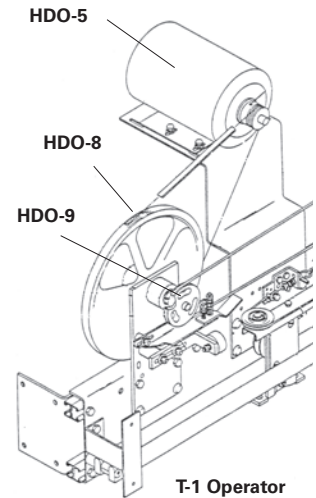

T-1 Operator

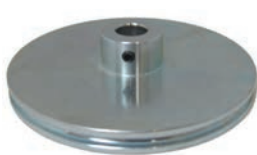

HDO-9



HDO-9A



HDO-10B

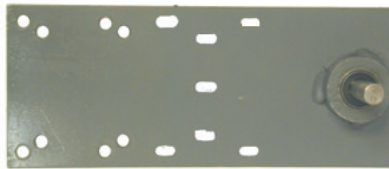

HDO-10



HDO-10A



HDO-11



HDO-12



HDO-13, HDO-13A



HDO-14



HDO-15



HDO-16



HDO-17

S.E.E.S. #	O.E.M. #	Description
HDO-5	3-40144-36	Motor, door operator, 1/4 HP, 230 VDC 1140 RPM, uses HCB-5 brushes (T-1), shaft 5-8"
HDO-5A	3-40196-50	Motor, door operator, 1/2 HP, 230 VDC, 1140 RPM (T-H), shaft 3/4"
HDO-5B		Sheave, 1.75" O.D., 5/8" I.D., 1-14" L
HDO-5C		Sheave, 1.25" O.D., 5/8" I.D., 1-14" L CTR PT
HDO-6	3-40151-13	Drive Sheave, 12" assembly for single speed doors
HDO-7	3-40151-14	Drive Sheave, 12" assembly for two speed doors
HDO-8	3-40132-72	Drive Sheave, 12" for above assemblies, 6 "J" grooves
HDO-9	3-40132-68	Sheave, 4" cable drive sheave
HDO-9A	3-40132-69	Idle Sheave, for T1 operator
HDO-10B	3-40129-08	Sheave, 2-1/2" for T1 operator
HDO-10	3-40132-81	Shaft, bearing bracket assembly
HDO-10A		Bearing, only, for HDO-10 assembly
HDO-11	3-19538-03	Cam
HDO-12	3-40130-33	Contact arm
HDO-13	3-28763-02	Moving contact bridge
HDO-13A	3-40304-67	Moving contact bridge, silver
HDO-14	34-1166-003	Spring, limit switch for HDO-17
HDO-15	34-1166-004	Spring, limit switch
HDO-16	16562	Contact, stationary
HDO-17	10084	Contact assembly, (6 sets) for limit switch

Door Parts and Equipment

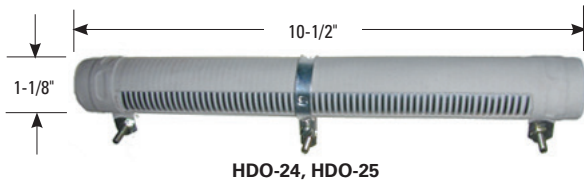
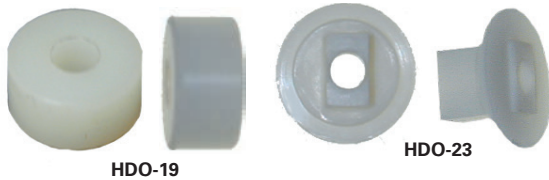

S.E.E.S. #	O.E.M. #	Description
HDO-18	34-0868-002	Contact arm for HDO-17 assembly
HDO-19	19474	Roller, limit switch for HDO-17 assembly
HDO-23	3-28764-02	Guide, contact, nylon
HW-11	35-1229-03	Idler sheave for car door hangers and safety edge retraction unit, 1-7/8" O.D., 1/2" bearing I.D.
HDO-24	3-26103-00	Resistor, 10 Ohm, 190 Watt
HDO-25	3-26103-05	Resistor, 20 Ohm, 190 Watt
HDO-44	3-40134-44	Door Clutch Roller, 3-40136-44, and arm left
HDO-45	3-40136-45	Door Clutch Roller, 3-40136-45, and arm right

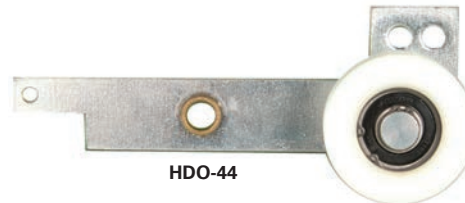

Safety Edge Assembly

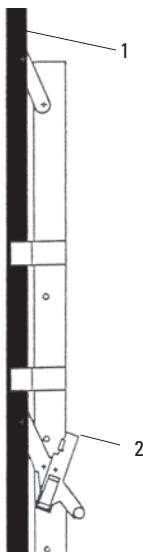

Item	S.E.E.S. #	O.E.M. #	Description
1	HDO-26	3-40041-87	Nosing, safety edge, 7 ft. aluminum
2	HDO-27	3-40157-90	Link assembly, lower L.H., safe edge
	HDO-28	3-40157-90	Link assembly, lower R.H., safe edge
	HDO-28A	3-40158-78	Upper pivot assembly, for safe edge



Door Parts and Equipment



HDO-29



HDO-30



HDO-31



HDO-32



HDO-36



HDO-33

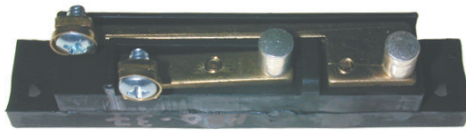

HDO-37



HDO-37A

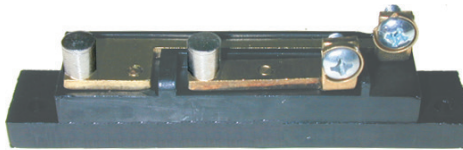

HDO-38



HDO-37B

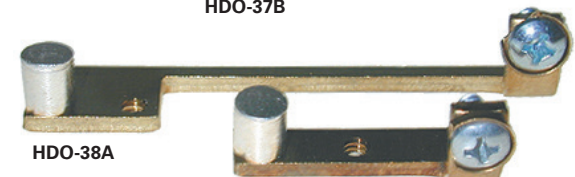

HDO-38A

HDO-38B



HDO-39



HDO-4

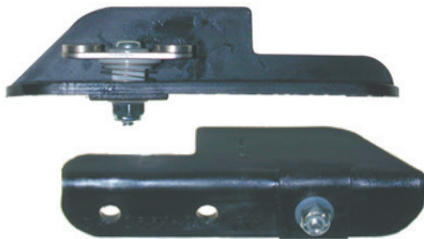

HDO-52

S.E.E.S. #	O.E.M. #	Description
HDO-29	HA-660-H	Sleeve bearing, teflon, 0.400" long x .752" O.D. x .479" I.D.
HDO-30	HA-660-F, 3-40235-40	Sleeve bearing, teflon, 1.010" long x .752" O.D. x .479" I.D.
HDO-31	3-40129-53	Sleeve bushing, steel, .526" long x .497" O.D.
HDO-32	34-1167-006	Spring, safety edge, 9-1/8" O.L.
HDO-33	3-40157-32	Spring, safety edge, 6-9/16" O.L.
HDO-34	3-40106-41	Spring, safety edge, 10" O.L.
HDO-36	19492	Roller, safety edge, nylon, 1.13" O.D., .50" I.D., .39" Thick
HDO-37	3-40117-56	Contact, R.H., stationary, M. interlock
HDO-37A	35-2551-25	Replacement Contact, 2-1/2" L, R.H.
HDO-37B	35-2551-24	Replacement Contact, 1-1/4" L, R.H.
HDO-38	3-40117-57	Contact, L.H., stationary, M. Interlock
HDO-38A	35-2551-26	Replacement Contact, 2-1/2" L, L.H.
HDO-38B	35-2551-23	Replacement Contact, 1-1/4" L, L.H.
HDO-39	3-40130-19	Bushing, 1" O.D., .50" I.D., 1.20" Thick Interlock Rubber Stop For "M" Interlock
HDO-4	3-40341-12, 3-19239-01	Movable contact assembly
HDO-52	3-40092-04	Interlock contact assembly, R.H.
HDO-52A	34-2551-004	Bracket for interlock contact, R.H.
HDO-53	3-40092-05	Interlock contact assembly, L.H.
HDO-53A	34-2551-005	Bracket for interlock contact, L.H.
HW-1-R	J825R	Interlock Roller, roller only, no pin

Machine Parts

Tachometer

S.E.E.S. #	O.E.M. #	Description
HMP-1A		Brush Cap for HMP-1 Tachometer
HCB-6		Brush for HMP-1 & MMP-100, silver grade carbon
HW-17	3-40010-13	Tachometer roller, 3-1/2" aluminum hub, 5/16" I.D.
HMP-14	3-40146-49	Seal, tach shaft for HMP-1 Tachometer
HMP-16	29014	Spreader, Bracket for 16" Gov Type "W"



"EK" Machine

S.E.E.S. #	O.E.M. #	Description
HMP-2	3-40147-21	Gasket, worm shaft
HMP-3	3-40151-88	Thrust bearing, worm shaft
HMP-4	3-40151-89	Drum shaft bearing, gear side
HMP-5	3-40151-87	Drum shaft bearing, drum side
HMP-6	3-40148-75	Felt seal for drum shaft, 2 required
HMP-20		Thrust Bearing, Kit SKF7412-BG1
HPAC-2	3-40360-86	Worm shaft seal, split, I.D. 2-3/4"
HPAC-3	3-20031-02	Seal Seat, 3-1/4" x 2-3/16"



"OH" Machine

S.E.E.S. #	O.E.M. #	Description
HMP-7	3-40003-42	Drum shaft bearing
HMP-8	3-40003-87	Seal for drum shaft
HMP-9	3-40003-40	Worm shaft bearing
HMP-10	3-40003-55	Gasket shim, .032"
HMP-11	3-40003-51	Gasket shim, 1/64"
HMP-12	3-40143-15	Sheave shaft for governor, 12-3/4"
HMP-13	3-40248-45	Flexible Coupling for "OH", "EK" machine
HPAC-1	3-40360-87, 3-40003-79	Worm Shaft Seal, split, I.D. 2-1/4"



Motors

S.E.E.S. #	O.E.M. #	Description
HS-1	16873	Vernier pressure washer
HS-2	14739	Vernier clutch washer, bronze
HS-3	3-26123-00	Drive Motor, Vernier B1, 72 RPM, 120V
HS-3A	3-26123-12	Drive Motor, Vernier B1, 72 RPM 230-240 VAC

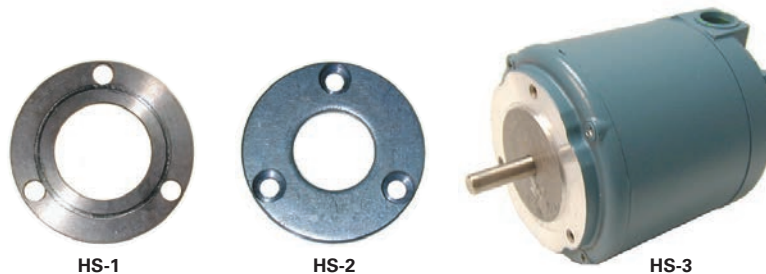

Rectifiers



HRT-1



HRT-2

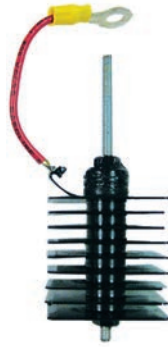

HRT-3

S.E.E.S. #	O.E.M. #	Description
HRT-1	3-36213-09	Door Rectifier, 7 plate 3" L
HRT-2	3-40155-28	Rectifier, 6 AMP 800V 3 phase bridge
HRT-3	3-36213-04	Selenium Rectifier, 1/2 wave hot stud 9plates with 3-1/2" leads
HRT-4	33-1094-008	Rectifier, Selenium 3PH, 5 Ter8-3/8" L 30 Plates 165VAC@750ma

Relay Parts

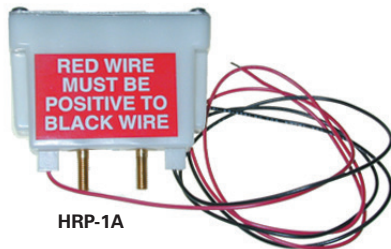

HRP-1A

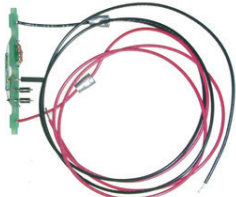

HRP-1AB

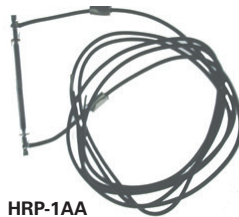

HRP-1AA

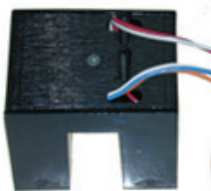

HRP-1B

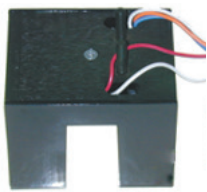

HRP-1D



HRP-3



HRP-3C

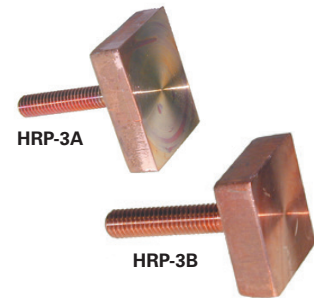

HRP-3A

HRP-3B



HRP-12A

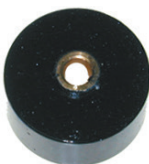

HRP-12B



HRP-12C

Magnetic Leveling Switches

S.E.E.S. #	O.E.M. #	Description
HRP-1	3-40156-88, 35-2557-15	Magnetic Leveling switch, mechanical style switch
HRP-1A	3-40156-89, 35-2557-17	Magnetic Leveling switch, electronic style switch

Repair Kits for Magnetic Switches

S.E.E.S. #	Description
HRP-1AA	Repair Kit for HRP-1, Replacement reed assembly with detailed instructions
HRP-1AB	Repair Kit for HRP-1A, Replacement reed printed circuit board assembly with detailed instructions

S.E.E.S. #	O.E.M. #	Description
HRP-1B	3-40230-10	Optical Leveling switch, 24 VDC, single beam
HRP-1C	3-40341-77, 3-40025-75	Optical Leveling switch, 110 VDC, dual beam
HRP-1D	3-40341-73	Optical Leveling switch, 24 VDC, dual beam
HRP-3	5737	Carbon contact, copper base, 1.70" L, 1.50 W, .75" thick
HRP-3A	5736	Copper contact, 1-1/2" square head
HRP-3B	5574	Copper contact, 1-3/4" x 2" x 1/2" thick
HRP-3C	5575	Carbon contact, 1-3/4" x 2" x 3/4" thick
HRP-12A	3-40119-03	Roller and arm assembly, for "J" limit switch
HRP-12B	26359	Roller, rubber for "J" limit switch, 1.62" O.D., .30" I.D., .75" thick
HRP-12C	3-40129-24	E-clip for HRP-12A roller

Relay Parts

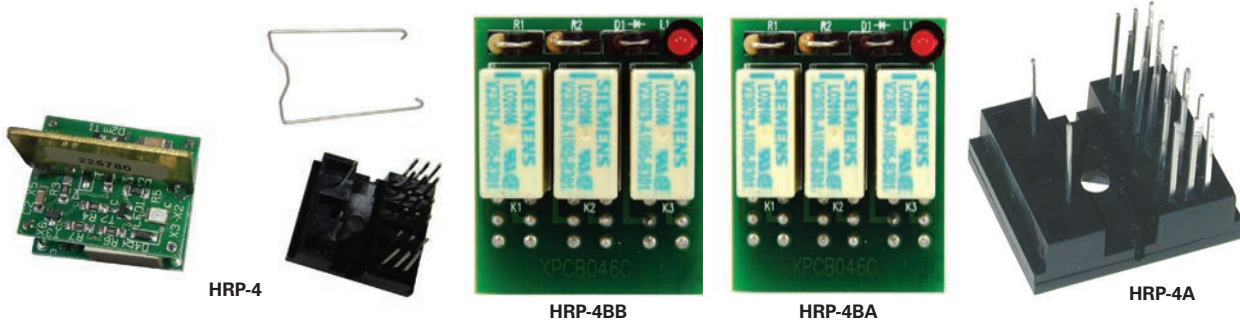

Ice Cube Relay

S.E.E.S. #	O.E.M. #	Description
HRP-4	3-40008-67	Relay, plug-in, 6 PDT, 24V
HRP-4BB		Solid State Replacement for HRP-4
HRP-4BA		Solid State Replacement for HRP-4B
HRP-4A	3-40008-75	Socket for relay
HRP-45	3-40014-98	Lamp, 28V, power supply indicator replacement lamp assembly
MIS-204D	3-40008-73	Rectifier, 3 Phase, 600V, 27.5 amp
MIS-204F		Rectifier, 3 Phase, 1200V, 25 amp



HRP-45



MIS-204D

PR-53	157-23-P200, KUP-14A15-12	Relay, plug-in, 3 PDT, 12 VAC
PR-72	157-23-Q200, KUP-14A15-24	Relay, plug-in, 3 PDT, 24 VAC
PR-14	157-23-T200, KUP-14A15-120	Relay, plug-in, 3 PDT, 120 VAC
PR-17	157-23-U200, KUP-14A15-240	Relay, plug-in, 3 PDT, 240 VAC
PR-21	157-23-F2LC, KUP14D35110	Relay, plug-in, 3 PDT, 110 VDC



PR-72

PR-32	670-0125, A759	Relay Socket, 3 Pole, Screw Terminal Base, 15 Amp, front mounted 6-32 screw terminals accept wires up to 14 AWG.
-------	-------------------	--

Type "F" Magnet Switch Moving Contact Assembly

(This arrangement normally open contact assembly)

Item	S.E.E.S. #	O.E.M. #	Description
1	HRP-17	3-28763-01	Contact Bridge
2	HDO-13	3-28763-02	Contact Bridge
3	HRP-19	28764	Guide
4	HRP-20	19486	Insulator
5	HRP-21	22100	Spring
6	HRP-22	3-20696-01	Washer
7	HRP-23	3-17592-03	"T" Head Screw

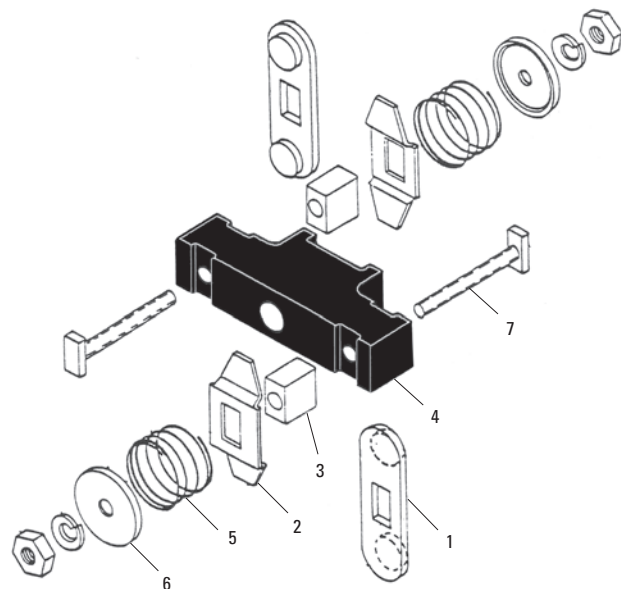

Relay Parts



HRP-13

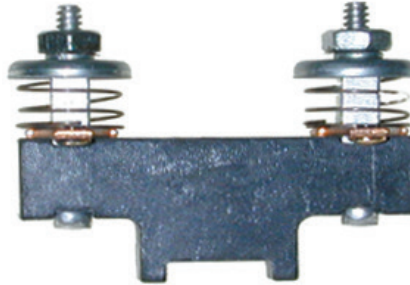

HRP-14

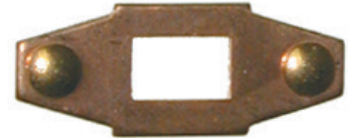

HDO-13



HRP-14B

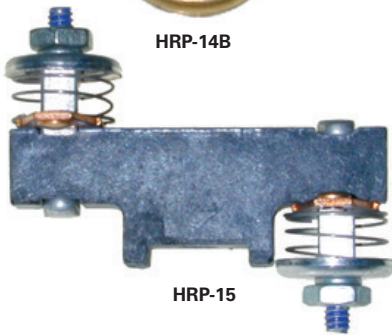

HRP-15



HRP-17



HRP-19



HRP-16

S.E.E.S. #	O.E.M. #	Description
HRP-13	10062	Contact assembly, 2 N.O., for type "F" magnet switch
HRP-14	3-10062-08	Contact assembly, 2 N.C., for type "F" magnet switch
HRP-14B	3-20696-02, 20696-B	Seat, washer, spring steel for HRP-14
HRP-15	3-10062-09	Contact assembly, 1 N.O., 1 N.C., for type "F" magnet switch
HDO-13	3-28763-02, 28763-E	Contact bridge, gold for HRP-14 and HRP-24
HDO-13A	3-40304-67	Contact bridge, silver

S.E.E.S. #	O.E.M. #	Description
HRP-16	3-10062-03	Contact assembly, 1 N.O., long block
HRP-17	3-28763-01	Contact bridge, heavy duty
HRP-19	28764	Contact bridge guide

Relay Parts



HRP-20



HRP-21



HRP-22



HRP-23

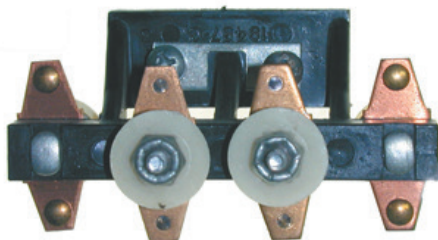

HRP-24

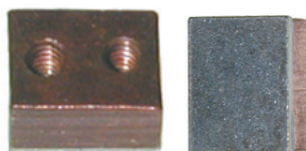

HRP-25



HRP-26

S.E.E.S. #	O.E.M. #	Description
HRP-20	19486	Insulator , Contact bridge, 1-7/8"
HRP-21	22100	Compression Spring for HRP-24 movable contact assembly, 1/2" O.D. x 3/4" long, 5-1/2 turns
HRP-22	3-20696-01, 20696-A	Spring seat washer for HRP-45 contact spring guide, used with HRP-21 spring
HRP-23	3-17592-03	Screw , "T" head, #6-32 x 1" used with HRP-21 and HRP-22
HRP-24	3-10062-13	Movable contact assembly , 2 N.O. and 2 N.C. contacts may be rearranged in the field to suit
HRP-25	3-20387-02, 20387-B	Stationary contact for "F" magnet switch and M.G., copper 1/2" x 3/8" x 5/16", with silver face
HRP-26	3-20397-00, 20397-B	Stationary contact , copper 3/4" x 1/2" x 3/8", with silver face
HRP-27	34-0725-005	Moving contact for Type "B", "B-1", and "B-2" Vernier and FA selector, type 300 stainless steel, 3/8" x 1-7/16"
HRP-28	3-20345-02	Moving contact for Type "B", "B-1", and 20345-B "B-2" Vernier and FA selector, type 300 stainless steel, contact surface 3/8" long
HRP-31	20324	Finger contact , 1/16" x 1/2" x 1-1/2" with oblong mounting hole 3/16" x 5/16" for car switch, manual door
HRP-5*	3-16562-08, 16562-M	Selector contact , 1-5/16" overall length
HRP-30*	3-20310-01, 30210-A	Selector contact , 1-13/16" overall length
HRP-30A*	3-40319-62	Selector contact , 2-1/2" overall length

*Button type selector contacts for type "B", "B-1", "B-2", and "FA" selectors and type "K" limit switch, 3/8" dia. head with 3/8" diameter silver contact.



HRP-27



HRP-28



HRP-31

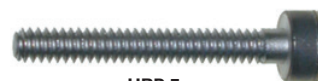

HRP-5



HRP-30



HRP-30A

Relay Parts

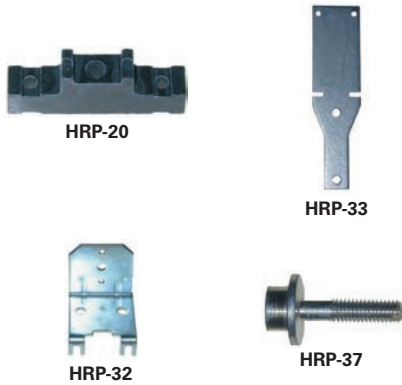

Type "BN" and "DN" Relays

S.E.E.S. #	O.E.M. #	Description
HRP-20	19486	Insulator , contact bridge insulator for 10062 series, movable "2" contact assemblies on AN, AM, AT, BN, and N relays
HRP-29		Base , Bakelite Relay/ Used On AN, AM, BN, DN Type Relays
HRP-32	3-28842-02, 28842-C	Core bracket for armature on AN and AM relays, used with HRP-33 and HRP-34
HRP-33	3-28841-02, 28841-C	Armature for AN, AM, and BN "6" contact relays
HRP-34	3-28841-01, 28841-B	Armature for AN, AM, and BN "4" contact relays
HRP-37	3-17592-02, 17592-C	Adjusting screw , 1-1/16" O.L., 10-32 thread for AN and AM relays

Contacts



Stationary Contacts for Relays "AN", "AM" and "BN"

S.E.E.S. #	O.E.M. #	Description
HRP-35	3-20456-01, 20456-A	Gold Contact , 29/32"
HRP-35A	3-40304-69	Silver Contact , 29/32"
HRP-35B	3-20456-02	Gold Contact , 51/64"
HRP-36	20456	Gold Contact , 63/64"
HRP-36A	3-40304-68	Silver Contact , 63/64"

S.E.E.S. #	O.E.M. #	Description
HRP-43	20386	M.G. start contact , movable with blowout copper, 1/2" wide with 3/8" x 1/2" silver contact
HRP-44	3-20386-02, 20386B	M.G. start contact , movable without blowout copper, 1/2" wide with 3/8" x 1/2" silver contact
HRP-39	17548	Contact , adjustable stationary contact stud for AT, F, & N relays, 13/16" overall with 5/16" dia. silver tip, used with HRP-14A contact bridge
HRP-40	3-17548-06, 17548-H	Contact , stationary, heavy duty stud 13/16" O.L., contact 5/16" dia. used with HRP-17 contact bridge
HRP-41	20429	Movable contact , Copper, 1" x 1" face, for "F" magnet switch
HRP-41A	3-23033-02	Shunt , Braided for HRP-41
HRP-41B	3-28918-02	Bracket , for HRP-41
HRP-42	21003	Carbon contact , stationary for HRP-41 movable contact
HRP-42A	20706	Relay Part , contact holder assembly for HRP-42
HRP-46	3-18266-2	Movable contact , assembly

HRP-41, HRP-41A and HRP-41B assembly

Relay Parts

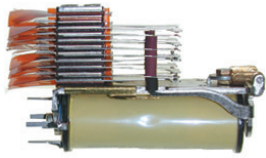

HRP-50

■ Type "C" Relay 4-1/2" O.L.

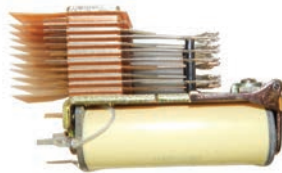

HRP-54



HRP-56

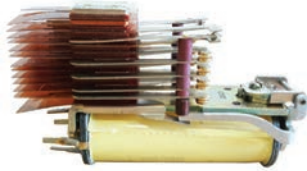

HRP-67



HRP-70

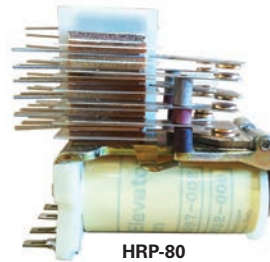

HRP-80

■ Type "J" Relay 2-1/4" O.L.



HRP-87

Telephone Type Relays

Relays S.E.E.S. #	O.E.M. #	Contacts Type	Contacts			Replacement Coils			
			NO	NC	SPDT	S.E.E.S. #	O.E.M. #	Voltage	
HRP-50	33-1097-001	C	4	2	2	HC-34B	34-1032-005	60	VDC
HRP-51	33-1097-004	C	3	2	0	HC-33	34-1032-006	120	VDC
HRP-52	33-1097-005	C	3	2	0	HC-40	34-1032-007	18	VAC
HRP-53	33-1097-006	C	3	2	0	HC-34	34-1032-003	120	VDC
HRP-54	33-1097-007	C	3	2	0	HC-34	34-1032-003	120	VDC
HRP-55	34-1097-008	C	2	1	1	HC-34C	34-1032-008	4	VDC
HRP-56	34-1097-009	C	2	1	1	HC-34	34-1032-003	120	VDC
HRP-57	34-1097-010	C	4	2	2	HC-34B	34-1032-005	60	VDC
HRP-58	34-1097-012	C	2	0	0	HC-42	34-1032-010	120	VDC
HRP-59	34-1097-013	C	3	2	0	HC-42	34-1032-010	120	VDC
HRP-60	34-1097-014	C	12	0	0	HC-34	34-1032-003	120	VDC
HRP-61	34-1097-015	C	0	0	8	HC-34	34-1032-003	120	VDC
HRP-62	34-1097-016	C	4	2	2	HC-42	34-1032-010	120	VDC
HRP-63	34-1097-017	C	2	1	1	HC-42	34-1032-010	120	VDC
HRP-65	34-1097-019	C	8	4	0	HC-34	34-1032-003	120	VDC
HRP-66	3-40155-37	C	4	0	2	HC-38	3-40155-15	120	VDC
HRP-67	3-40155-38	C	6	2	2	HC-38	3-40155-15	120	VDC
HRP-68	3-40155-40	C	6	0	4	HC-38	3-40155-15	120	VDC
HRP-69	3-40220-69	C	8	4	0	HC-35	3-40258-34	24	VDC
HRP-70	3-40258-28	C	6	2	2	HC-35	3-40258-34	24	VDC
HRP-71	3-40267-98	C	6	4	0	HC-35	3-40258-34	24	VDC
HRP-72	3-36353-01	C	0	0	6	HC-34	34-1032-003	120	VDC
HRP-80	34-1097-002	J	4	2	0	HC-41	34-1032-009	60	VDC
HRP-81	34-1097-003	J	2	2	0	HC-44	34-1032-012	120	VDC
HRP-83	34-1097-005	J	4	2	0	HC-44	34-1032-012	120	VDC
HRP-84	34-1097-006	J	4	2	0	HC-44	34-1032-012	120	VDC
HRP-85	34-1097-007	J	4	2	0	HC-43	34-1032-011	120	VDC

HRP-85A	42765-1	Terminals for telephone type relays
HRP-85B	35-1094-004	Arc Suppressor Assembly for telephone type relays
HRP-87		Photo SW, #CP18LDND2/ dark operate
HRP-88	3-40332-16	Contactors, 3 Pole 25A, 80 VDC Type MG5



HT-1



HT-4



HT-8

Timers

S.E.E.S. #	O.E.M. #	Description
HT-1	3-40224-09	Range 0.5 - 30.0 sec. "CJ-1" Model
HT-2	3-40224-10	Range 3 sec. - 5 min., "CJ-6" Model
HT-3	3-40152-78	Range 0.6 - 60 sec., 115 VDC
HT-4	3-40224-09	Range 0.5 - 30 sec., 24 VDC
HT-7	3-40269-81	Range 3 sec.- 8 min., 24 VDC
HT-8	3-36187-004	Vacuum tube #5693

Transformers

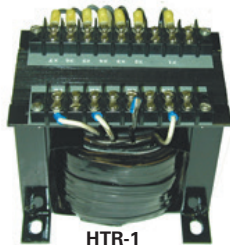

HTR-1



HTR-4



HCAP-1



HRES-1

S.E.E.S. #	O.E.M. #	Description
HTR-1	03-026137-013	Transformer , 1 KVA, Primary voltage 240/480, Secondary voltage 117/254
HTR-2	3-40008-71	Transformer for controller, 3 phase, 2.8KVA
HTR-3	3-40008-87	Transformer , 3 phase, Primary voltage 180, 23-26-29 sec.
HTR-4	3-40155-19	Transformer , 208/230 VAC Primary 24-98 sec. 150 VA
HCAP-1	3-40163-08	Capacitor , 250V, 270-324MFD for EVC-ELC Control Drawers
HRES-1	3-40049-83	Resistor , 1.6 ohm 400 watt, 8-1/2"

Printed Circuit Boards and Stepper Switch

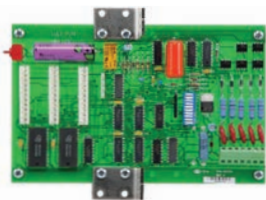

HRP-75A

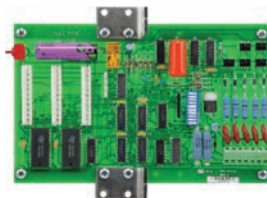

HRP-75B

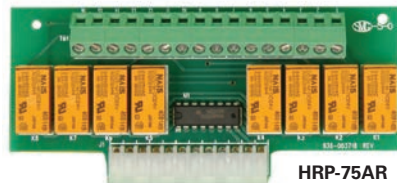

HRP-75AR



HDO-2D



HPC-1



MIS-100K

Stepper Switch

S.E.E.S. #	O.E.M. #	Description
MIS-100K		Stepper Lube Kit , Assorted lubricants, specially formulated for maintaining stepping switch wear points. Prolongs life, improves performance
HRP-75A	HA-2544-L	Stepper Switch , 24 VDC, 16 position, electronic replacement
HRP-75B	HA-2544-M	Stepper , electronic, 110 VDC, 16 position
HRP-75AR	7403.901	Relay Board , stepper, for HRP-75A and HRP-75B

Printed Circuit Boards

S.E.E.S. #	O.E.M. #	Description
HPC-1	3-40303-43	Switching Power Supply PC Board , 115 VAC primary, 5 VDC secondary @ 16 amps
HPC-2	3-40303-43	PCB , GMC Amplifier GMG Level
HPC-3	3-40337-61	Power Supply , +5V & 12V +24 VDC
HDO-2D	3-40007-82	Amplifier PC Board , for type "HE" safe ray
HPC-200	3-40337-61	PCB , Load Weigh Amp, Miconic V, LVL C
HPC-201	3-40337-61	PCB , Heatsink Board Assembly

Wheels and Rollers

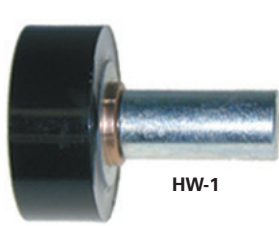

HW-1

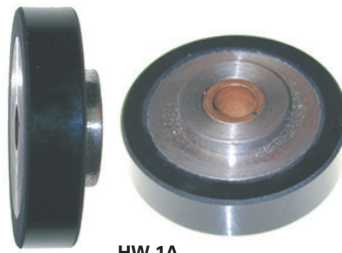

HW-1A

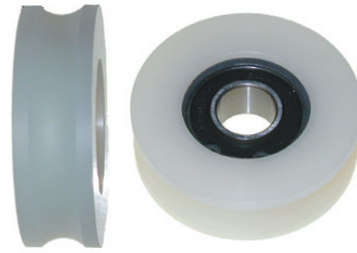

HW-15



HW-2

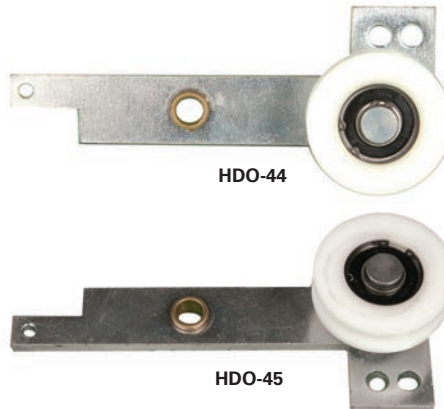

HDO-44

HDO-45

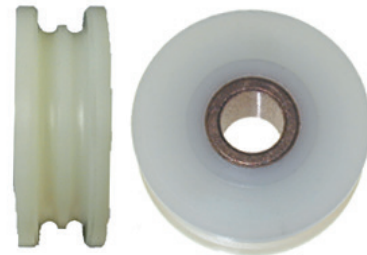

HW-11

S.E.E.S. #	O.E.M. #	Description
HW-1	35-2551-006	Interlock Roller and pin assembly, for type "M" Interlock, polyurethane roller 1-3/4" diameter x 3/4" wide face, 5/8" diameter pin extends 1-3/8" from roller
HW-1A	3-16497-00	Roller assembly , door clutch, 2-1/4" O.D. x 9/16" face with 7/16" bore
HW-15	35-727-30	Door Clutch Roller , 2-9/16" O.D. x 3/4" wide with 5/8" bearing I.D., for door clutch arm R.H. or L.H.
HDO-44	3-40136-44	Door Clutch Roller , and L.H. arm
HDO-45	3-40136-45	Door Clutch Roller , and R.H. arm
HW-2	3-16847-01	Door hanger Roller , nylon, 3-11/16" O.D. x 3/4" wide, .6299" bearing I.D.
HW-11	35-1229-03	Idler sheave for car door hangers and safety edge retraction unit, 1-7/8" O.D., 1/2" bearing I.D.
HW-14	AR928A3 12G1	Hanger Roller , 3-3/8" diameter, eccentric shaft, 5/8"-18 threaded, .220 shoulder
HW-14A		Hanger Roller , 3-3/8" O.D. with Special eccentric shaft, 5/8"-18 threaded, .130 shoulder
HW-14S		Shaft for HW-14 , Eccentric, 5/8" thread



HW-14



HW-14S

Wheels and Rollers



HW-6

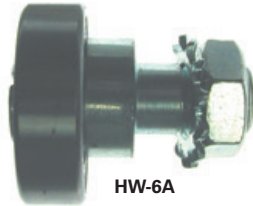

HW-6A



HW-6B



HW-3



HW-3A

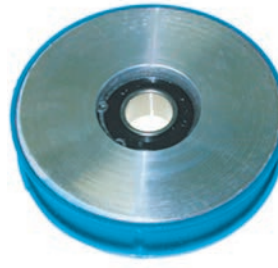

HW-7

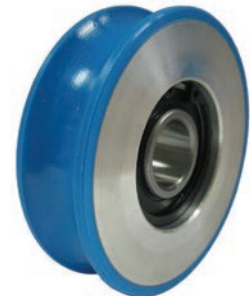

HW-8



MIS-239



S.E.E.S. #	O.E.M. #	Description
HW-6	3-40130-77, 3-40130-79	Hanger roller, for B-4 hanger, 3-5/16" O.D. with .625" bearing I.D.
HW-6A	34-1004-001, 34-0792-097	Eccentric upthrust, 1" O.D. 7/16" W face
HW-6B	3-26064-00	Eccentric roller, 1-3/8" O.D., 1.343" O.L, 5/8" shaft
HW-6C		Upthrust, Eccentric 6203 Brg 5/8-18 Thread
HW-7	3-40157-63	Hanger roller, 3-11/16" diameter with .6299" bearing I.D.
HW-8	3-40157-60	Hanger roller, 2-5/8" diameter with .6299" bearing I.D.
HW-3	3-40150-71	Roller guide wheel, 3-1/2" O.D. x 1-5/16" W, with 3/4" W tire face, .6693" bearing I.D.
HW-3A	3-40196-75	Eccentric wheel support kit, includes eccentric pin, eccentric, washer, axle pin and hardware for roller guide wheel HW-3
MIS-239	J420 3-40151-00	Guide Roller, 3-1/2" O.D. x 1-5/16" W, with 3/4" wide tire face .6693" bearing I.D.
HW-9	3-40158-67	Roller guide wheel, 3-1/2" O.D. x 1-1/16" W, with 3/4" W tire face, .5119" bearing I.D.
HW-10	3-40134-75	Upthrust roller used on car door hangers for "TH" operator, 3-3/8" diameter with 3/4" W face, .6299" bearing I.D.



HW-9

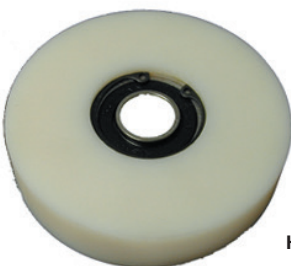
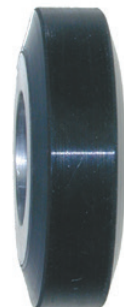

HW-10



Wheels and Rollers



WW-20



HW-4



HW-5

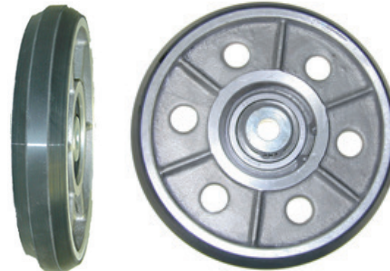

HW-12



HW-5B



HW-12A



HW-12C

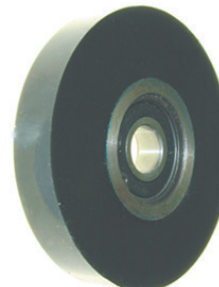

HW-16



HW-17

S.E.E.S. #	O.E.M. #	Description
WW-20	3-11143-05 35-1159-012	Roller Guide Wheel, 3" diameter, .6693" bearing I.D., 1" wide with 1/2" tire face
HW-4	3-40196-74	Roller guide wheel, 3-1/2" O.D. x 1-5/16" W, 1" tire face, with .7874" bearing I.D.
HW-5	35-1159-004	Roller guide wheel, 5" O.D. x 1-1/8" W, 7/16" W tire face, bearing has steel inner sleeve with .630" bearing I.D.
HW-5A	J-424	Roller guide wheel, 5" O.D. x 1-1/8" W, 7/16" Face 6205 Brg, .985" I.D., No Bushings, Face Roller
HW-5B		Roller guide wheel, 5" O.D. x 1-1/8" W-Face 6205 Brg, .985" I.D., Side Roller
HW-12	35-1159-002	Roller guide wheel, 8" O.D. x 1-3/8" W, 1/2" W tire face, .630" bearing I.D., bushing w/ 5/8" dia., Hardware part # HW-12C
HW-12A	3-40329-10	Roller guide, 8" x 1-1/4", .6204" bearing
HW-12AH	3-40329-1	Roller guide, 8" O.D. x 3/4" Face x .787" I.D., HD 90 Duro
HW-12B	3-40119-75	Roller guide, 10" O.D. x 1-5/16" W 3/4" Tire, Z995204 Brng
HW-12C		Hardware kit for HW-12A, bolt, retainer, spacer, washer, nut
HW-16	3-19373-02	Limit switch roller, 3-1/2"
HW-17	3-40010-13	Tach roller, 3-1/2" aluminum hub, 5/16" I.D.
HW-18	3-40155-59	Door Hanger & Roller, assembly, with 3-5/16" O.D x 3/4" W roller

Decimal and Metric Equivalents

Fractions	Decimals In.	Metric M.M.
1/64	.015625	.39688
3/64	.046875	1.19062
5/64	.078125	1.98437
7/64	.109375	2.77812
5/32	.140625	3.57187
3/16	.171875	4.36562
7/32	.203125	5.15937
1/4	.234375	5.95312
9/32	.265625	6.74687
5/16	.296875	7.54062
11/32	.328125	8.33437
3/8	.359375	9.12812
13/32	.390625	9.92187
7/16	.421875	10.71562
15/32	.453125	11.50937
1/2	.484375	12.30312

Fractions	Decimals In.	Metric M.M.
33/64	.515625	13.09687
17/32	.53125	13.49375
35/64	.546875	13.89062
9/16	.5625	14.28750
37/64	.578125	14.68437
19/32	.59375	15.08125
39/64	.609375	15.47812
5/8	.625	15.87500
41/64	.640625	16.27187
21/32	.65625	16.66875
43/64	.671875	17.06562
11/16	.6875	17.46250
45/64	.703125	17.85937
23/32	.71875	18.25625
47/64	.734375	18.65312
3/4	.750	19.05000
49/64	.765625	19.44687
25/32	.78125	19.84375
51/64	.796875	20.24062
13/16	.8125	20.63750
53/64	.828125	21.03437
27/32	.84375	21.43125
55/64	.859375	21.82812
7/8	.875	22.22500
57/64	.890625	22.62187
29/32	.90625	23.01875
59/64	.921875	23.41562
15/16	.9375	23.81250
64/64	.953125	24.20937
31/32	.96875	24.60625
63/64	.984375	25.00312
1	1.00	25.40000

Courtesy of ELEVATOR WORLD, INC., from Elevator Maintenance Manual. Copyright © 1999. Reprinted by permission.